

# IRF7836PbF

HEXFET<sup>®</sup> Power MOSFET

## Applications

- Synchronous MOSFET for Notebook Processor Power
- Synchronous Rectifier MOSFET for isolated DC-DC Converters in Networking Systems

<b>V<sub>DSS</sub></b>	<b>R<sub>DS(on)</sub> max</b>	<b>Qg</b>
<b>30V</b>	<b>5.7mΩ @ V<sub>GS</sub> = 10V</b>	<b>18nC</b>

## Benefits

- Very Low R<sub>DS(on)</sub> at 4.5V V<sub>GS</sub>
- Low Gate Charge
- Fully Characterized Avalanche Voltage and Current
- 100% Tested for R<sub>G</sub>
- Lead-Free

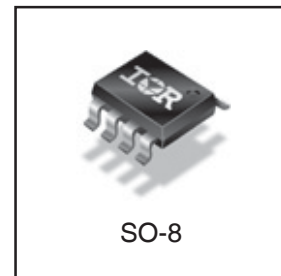
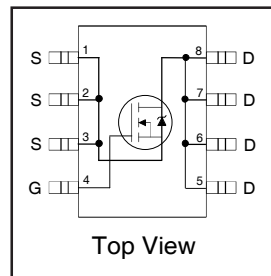

## Absolute Maximum Ratings

	Parameter	Max.	Units
V <sub>DS</sub>	Drain-to-Source Voltage	30	V
V <sub>GS</sub>	Gate-to-Source Voltage	± 20	
I <sub>D</sub> @ T <sub>A</sub> = 25°C	Continuous Drain Current, V <sub>GS</sub> @ 10V	17	A
I <sub>D</sub> @ T <sub>A</sub> = 70°C	Continuous Drain Current, V <sub>GS</sub> @ 10V	13	
I <sub>DM</sub>	Pulsed Drain Current ①	130	
P <sub>D</sub> @ T <sub>A</sub> = 25°C	Power Dissipation ④	2.5	W
P <sub>D</sub> @ T <sub>A</sub> = 70°C	Power Dissipation ④	1.6	
	Linear Derating Factor	0.02	W/°C
T <sub>J</sub>	Operating Junction and	-55 to + 150	°C
T <sub>STG</sub>	Storage Temperature Range		

## Thermal Resistance

	Parameter	Typ.	Max.	Units
R <sub>θJL</sub>	Junction-to-Drain Lead ⑤	—	20	°C/W
R <sub>θJA</sub>	Junction-to-Ambient ④⑤	—	50	

Notes ① through ⑤ are on page 9

## Static @ T<sub>J</sub> = 25°C (unless otherwise specified)

	Parameter	Min.	Typ.	Max.	Units	Conditions
BV <sub>DSS</sub>	Drain-to-Source Breakdown Voltage	30	—	—	V	V <sub>GS</sub> = 0V, I <sub>D</sub> = 250μA
ΔBV <sub>DSS</sub> /ΔT <sub>J</sub>	Breakdown Voltage Temp. Coefficient	—	0.024	—	V/°C	Reference to 25°C, I <sub>D</sub> = 1mA
R <sub>DS(on)</sub>	Static Drain-to-Source On-Resistance	—	4.5	5.7	mΩ	V <sub>GS</sub> = 10V, I <sub>D</sub> = 17A ③
		—	5.7	7.1		V <sub>GS</sub> = 4.5V, I <sub>D</sub> = 13A ③
V <sub>GS(th)</sub>	Gate Threshold Voltage	1.35	1.8	2.35	V	V <sub>DS</sub> = V <sub>GS</sub> , I <sub>D</sub> = 50μA
ΔV <sub>GS(th)</sub>	Gate Threshold Voltage Coefficient	—	-6.2	—	mV/°C	
I <sub>DSS</sub>	Drain-to-Source Leakage Current	—	—	1.0	μA	V <sub>DS</sub> = 24V, V <sub>GS</sub> = 0V
		—	—	150		V <sub>DS</sub> = 24V, V <sub>GS</sub> = 0V, T <sub>J</sub> = 125°C
I <sub>GSS</sub>	Gate-to-Source Forward Leakage	—	—	100	nA	V <sub>GS</sub> = 20V
	Gate-to-Source Reverse Leakage	—	—	-100		V <sub>GS</sub> = -20V
gfs	Forward Transconductance	70	—	—	S	V <sub>DS</sub> = 15V, I <sub>D</sub> = 13A
Q <sub>g</sub>	Total Gate Charge	—	18	27	nC	V <sub>DS</sub> = 15V V <sub>GS</sub> = 4.5V I <sub>D</sub> = 13A See Fig. 17 & 18
Q <sub>gs1</sub>	Pre-V <sub>th</sub> Gate-to-Source Charge	—	4.1	—		
Q <sub>gs2</sub>	Post-V <sub>th</sub> Gate-to-Source Charge	—	1.5	—		
Q <sub>gd</sub>	Gate-to-Drain Charge	—	5.8	—		
Q <sub>godr</sub>	Gate Charge Overdrive	—	6.6	—		
Q <sub>sw</sub>	Switch Charge (Q <sub>gs2</sub> + Q <sub>gd</sub> )	—	7.3	—		
Q <sub>oss</sub>	Output Charge	—	11	—	nC	V <sub>DS</sub> = 16V, V <sub>GS</sub> = 0V
R <sub>g</sub>	Gate Resistance	—	1.0	1.7	Ω	
t <sub>d(on)</sub>	Turn-On Delay Time	—	8.9	—	ns	V <sub>DD</sub> = 15V, V <sub>GS</sub> = 4.5V I <sub>D</sub> = 13A Clamped Inductive Load See Fig. 15
t <sub>r</sub>	Rise Time	—	11	—		
t <sub>d(off)</sub>	Turn-Off Delay Time	—	12	—		
t <sub>f</sub>	Fall Time	—	4.2	—		
C <sub>iss</sub>	Input Capacitance	—	2400	—	pF	V <sub>GS</sub> = 0V V <sub>DS</sub> = 15V f = 1.0MHz
C <sub>oss</sub>	Output Capacitance	—	500	—		
C <sub>rss</sub>	Reverse Transfer Capacitance	—	230	—		

## Avalanche Characteristics

	Parameter	Typ.	Max.	Units
E <sub>AS</sub>	Single Pulse Avalanche Energy ②	—	130	mJ
I <sub>AR</sub>	Avalanche Current ①	—	13	A

## Diode Characteristics

	Parameter	Min.	Typ.	Max.	Units	Conditions
I <sub>S</sub>	Continuous Source Current (Body Diode)	—	—	3.1	A	MOSFET symbol showing the integral reverse p-n junction diode.
I <sub>SM</sub>	Pulsed Source Current (Body Diode) ①	—	—	130	A	
V <sub>SD</sub>	Diode Forward Voltage	—	—	1.0	V	T <sub>J</sub> = 25°C, I <sub>S</sub> = 13A, V <sub>GS</sub> = 0V ③
t <sub>rr</sub>	Reverse Recovery Time	—	15	23	ns	T <sub>J</sub> = 25°C, I <sub>F</sub> = 13A, V <sub>DD</sub> = 15V
Q <sub>rr</sub>	Reverse Recovery Charge	—	17	26	nC	di/dt = 500A/μs ③ See Fig. 16
t <sub>on</sub>	Forward Turn-On Time	Intrinsic turn-on time is negligible (turn-on is dominated by LS+LD)				

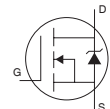

# IRF7836PbF

International  
**IOR** Rectifier

## SO-8 Package Outline (Dimensions are shown in millimeters (inches))

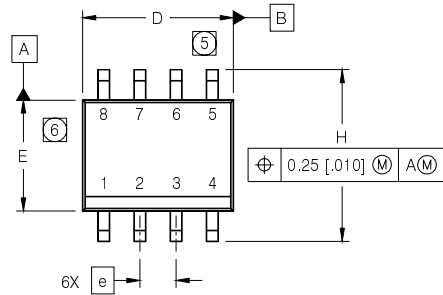

DIM	INCHES		MILLIMETERS	
	MIN	MAX	MIN	MAX
A	.0532	.0688	1.35	1.75
A1	.0040	.0098	0.10	0.25
b	.013	.020	0.33	0.51
c	.0075	.0098	0.19	0.25
D	.189	.1968	4.80	5.00
E	.1497	.1574	3.80	4.00
e	.050 BASIC		1.27 BASIC	
e1	.025 BASIC		0.635 BASIC	
H	.2284	.2440	5.80	6.20
K	.0099	.0196	0.25	0.50
L	.016	.050	0.40	1.27
y	0"	8"	0"	8"

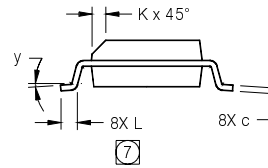
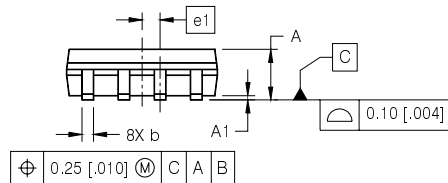

### NOTES:

1. DIMENSIONING & TOLERANCING PER ASME Y14.5M-1994.
2. CONTROLLING DIMENSION: MILLIMETER
3. DIMENSIONS ARE SHOWN IN MILLIMETERS [INCHES].
4. OUTLINE CONFORMS TO JEDEC OUTLINE MS-012AA.
- ⑤ DIMENSION DOES NOT INCLUDE MOLD PROTRUSIONS. MOLD PROTRUSIONS NOT TO EXCEED 0.15 [0.006].
- ⑥ DIMENSION DOES NOT INCLUDE MOLD PROTRUSIONS. MOLD PROTRUSIONS NOT TO EXCEED 0.25 [0.010].
- ⑦ DIMENSION IS THE LENGTH OF LEAD FOR SOLDERING TO A SUBSTRATE.

### FOOTPRINT

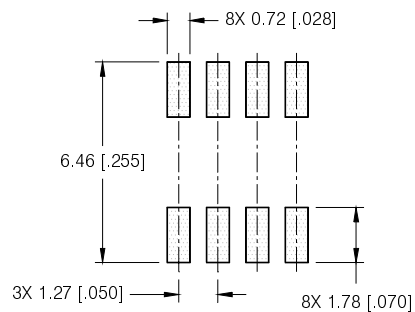

## SO-8 Part Marking

EXAMPLE: THIS IS AN IRF7101 (MOSFET)

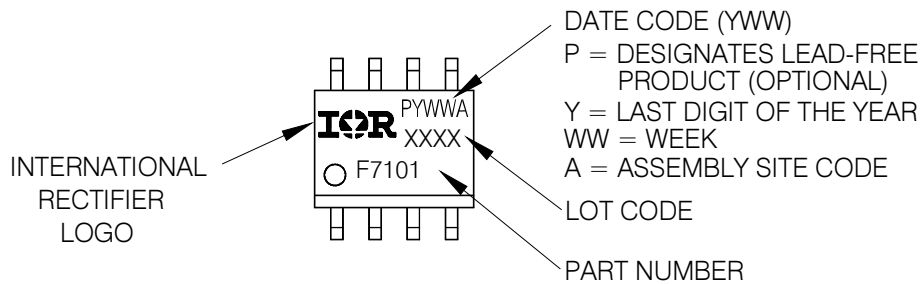

Dimensions are shown in millimeters (inches)

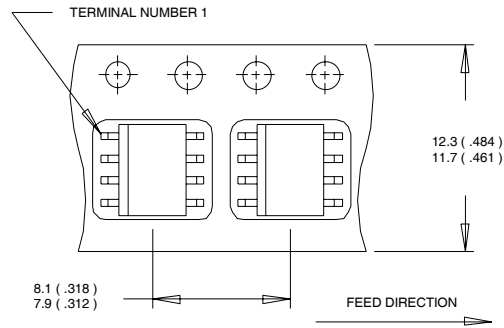

- NOTES:
1. CONTROLLING DIMENSION : MILLIMETER.
  2. ALL DIMENSIONS ARE SHOWN IN MILLIMETERS(INCHES).
  3. OUTLINE CONFORMS TO EIA-481 & EIA-541.

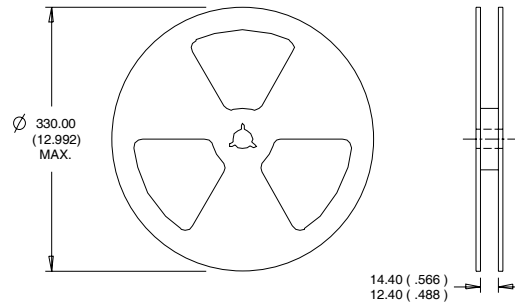

- NOTES :
1. CONTROLLING DIMENSION : MILLIMETER.
  2. OUTLINE CONFORMS TO EIA-481 & EIA-541.

**Notes:**

- ① Repetitive rating; pulse width limited by max. junction temperature.
- ② Starting  $T_J = 25^\circ\text{C}$ ,  $L = 1.4\text{mH}$ ,  $R_G = 25\Omega$ ,  $I_{AS} = 13\text{A}$ .
- ③ Pulse width  $\leq 400\mu\text{s}$ ; duty cycle  $\leq 2\%$ .
- ④ When mounted on 1 inch square copper board.
- ⑤  $R_\theta$  is measured at  $T_J$  approximately  $90^\circ\text{C}$ .

Data and specifications subject to change without notice.  
 This product has been designed and qualified for the Consumer market.